



Preliminary Product Specification

Module name: C0283QGLC-T

Issue date: 2008/12/03

Version: 2.3

Customer		
Panox Display sales@panoxdisplay.com skype: panoxwesley		
Approved by Customer		
Approved by CMEL		
PD Division	ENG Division	QA Dept

Note:

1. The information contained may be changed without prior notice before approval. It is therefore advisable to contact Chi MEI EL Corp. before designing your product.



Reversion History

Version	Date	Page	Description
Ver.1.0	2007/11/5	All	Specification was first issued
Ver.1.1	2007/11/5	13	CIE(Red_y) 0.34->0.33, CIE(Red_y) 0.28->0.29
Ver.1.2	2007/11/7	9	Add Image Data format (CPU Interface)
		11	Add RS expression
		13	Add Image Data format (RGB Interface)
		17~19	Add Capacitance Information
Ver.1.3	2007/11/9	20	Add External Drawing
		22	Add Package Drawing
Ver.1.4	2007/11/22	20	Mod External Drawing
Ver.1.5	2007/11/28	14	Mod Electro-Optical Characteristic, Vgh/Vgl
		3	Mod Mechanical Data
Ver.1.6	2007/12/06	14	Mod Electro-Optical Characteristic
		21	Add Cautions for installing and assembling
		22	Mod Reliability Test
Ver.1.7	2007/12/18	14	Mod Electro-Optical Characteristic, Vgh/Vgl
Ver.1.8	2008/04/02	14	Mod Electro-Optical Characteristic(CIE: Ry, Gx)
		20	Mod External Drawing
Ver.1.9	2008/05/15	23	Mod Package Drawing
Ver.2.0	2008/05/28	14	Modify Electro-Optical Characteristic (CIE_Gx)
		22	Modify RA Test Condition (Thermal Shock-20C=>-40C)
Ver.2.1	2008/05/30	4	Modify Absolute Maximum ratings
Ver.2.2	2008/11/05	4	Mod Absolute maximum ratings (Modify to the Panel Operating Condition)
		11	Instruction data => Parameter data
		13	Modify the timing chart of RGB
		14	Add Gamma Setting Group Code
		18	Mod Pin-46 to be Output Pin from IC
		18	Add Notice of Pin-45/46/47/48 that: SDI=SDIN 、 SDO=SDOUT CSB=CS=NCS 、 RW_WRB=SCL
		20	Add “Test and measurement conditions”
		21	Add Notice of “Handling & Storage”
		22	Add Label (Optional) ID Position on Drawing
Ver.2.3	2008/12/03	14	Mod Lifetime (From 20K to 30K)

1. Purpose:

This documentation defines general product specification for OLED module supplied by CMEL. The information described in this technical specification is tentative. Please Contact CMEL's representative while your product is modified.

2. General Description:

- Driving Mode: Active Matrix.
- Color Mode: Full Color (262K color)
- Driver IC: S6E63D6, COG Assembly
- Interface:
 1. MPU i80-system 18-/16-/9-/8-bit bus interface
 2. MPU i68-system 18-/16-/9-/8-bit bus interface
 3. Serial data transfer interface (SPI)
 4. RGB 18-/16-/6-bit bus interface (DOTCLK, VSYNC, HSYNC, DE, DB17-0)
- Application: Cell phone etc..
- RoHS Compatible

3. Mechanical Data:

No.	Items	Specification	Unit
1	Diagonal Size	2.83"	Inch
2	Resolution	240 x RGB x 320	
3	Pixel Pitch	0.060 × 0.180	mm
4	Active Area	43.2 x 57.6	mm
5	Outline Area	49.1 x 67.3	mm
6	Thickness	2.75 (Typ) ; 2.9 (Max)	mm
7	Weight	21	g

4. Absolute Maximum ratings:

4.1 Absolute ratings of environment :

Item	Symbol	Value		Unit	Note
		Min.	Max.		
Storage Temperature	T _{ST}	-40	+80	°C	(1)
Operating Ambient Temperature	T _{OP}	-20	+60	°C	(2)

Note (1) The storage duration for both critical temperature (-40 & 80°C) meet reliability test criteria.

(2) The operating duration for both critical temperature (-20 & 60°C) meet reliability test criteria.

4.2 Electrical absolute ratings :

Item	Symbol	Unit	Value
Power supply voltage 1	AR_Vdd	V	+4.6V +/- 0.05
Power supply voltage 2	AR_Vss	V	-4.4V +/- 0.1
Power supply voltage 3	VCI	V	+2.5 ~ +3.3
Power supply voltage 4	VDD3 (IOVcc)	V	+1.65 ~ +3.3

5. Electrical Characteristic:
5.1 DC Characteristic

(Ta = -40℃ ~ 85℃, VSS = 0V)

Characteristic	Symbol	CONDITION	MIN	TYP	MAX	Unit	Note
Driving voltage	VGH	-	3.0	-	8.0	V	
	VGL	-	-8.0	-	-3.0	V	
	VINT	-	-4.0	-	-1.0	V	
Logic Operating Voltage	RVDD	-	1.45	1.5	1.55	V	
Operating frequency	fosc	Frame frequency = 60Hz Display line = 320 line	1161.1	1290.2	1419.3	kHz	
1st booster input voltage	VCI1	-	2.1	-	2.75	V	
1st booster output voltage	VLOUT1	Without load	+4.6	-	+5.5	V	
1st booster output efficiency	VLOUT1	I _{VLOUT1_LOAD} = 2.3mA	90	95	-	%	
2nd booster output voltage	VLOUT2	Without load	-	7.8	-	V	
2nd booster output efficiency	VLOUT2	I _{VLOUT2_LOAD} = 0.1mA	90	93	-	%	
3rd booster output voltage	VLOUT3	Without load	-	-10.6	-	V	
3rd booster output efficiency	VLOUT3	I _{VLOUT3_LOAD} = 0.1mA	90	93	-	%	
Source Output voltage deviation (channel to channel)	-	-	-	±5	-	mV	
Source Output voltage difference (nearest channel)	-	20 Gray Pattern	-	5	-	mV	
Output voltage deviation (Chip to Chip)	-	-	-	±15	-	mV	
Output voltage deviation (Chip to Chip)	-	-	-	±15	-	mV	
Source driver output voltage range	Vso	-	0.3	-	4.2	V	
Driving voltage	dVGH	voltage deviation	-	-	300	mV	
	dVGL	voltage deviation	-	-	300	mV	
Current consumption during normal operation	IVDD3	No load, Ta = 25 °C	-	1.0	5.0	μA	*1
	IVCI		+	3.5	4.0	mA	
Stand by mode current	IVDD3	Ta = 25 °C	+	0.1	5.0	μA	
	IVCI		-	10	20	μA	

Note

1. VDD3=1.8V, VCI=2.8V, fosc=1290.2KHz (320 display line), NL[5:0]="10_1000", SAP[2:0]="101", DC22[2:0]="100", DC12[2:0]="010", BT[1:0]=10, VQ[3:0]="1000", VGH[4:0]="10100", VGL[4:0]="10100", VINT[3:0]="2101"

Characteristic	Symbol	CONDITION	MIN	TYP	MAX	Unit	Note
Power Supply Voltage	VCI	Operating Voltage	2.5	2.8	3.3	V	
Power Supply Voltage	VDD3	I/O supply Voltage	1.65	1.8	3.3	V	
Logic High level input voltage	V _{IH}		0.7*VDD3		VDD3	V	
Logic Low level input voltage	V _{IL}		0.0		0.3*VDD3	V	
Logic High level output voltage	V _{OH}	IOUT = -1mA	0.8*VDD3		VDD3	V	
Logic Low level output voltage	V _{OL}	IOUT = +1mA	0.0		0.2*VDD3	V	
Analog High level output voltage	EL_ON _{OH}	8uA	1.8		VCI	V	
Analog Low level output voltage	EL_ON _{OL}	8uA	0		0.3	V	

Table 81. DC Characteristics 3

(VDD3 = 1.65~3.3V, VCI = 2.5~3.3V, Ta = 25℃)

Characteristic	Symbol	CONDITION	MIN	TYP	MAX	Unit	Note
VREG1OUT			4.185	4.2	4.215	V	

Panox Display
sales@panoxdisplay.com
 skype: panoxwesley

www.panoxdisplay.com

5.2 AC Characteristic

5.2.1 CPU interface M68

(VDD3 = 1.65 to 3.3V, TA = -40 to +85°C)

Characteristic		Symbol	Specification		Unit
			Min.	Max.	
Cycle time	Write	tCYCW68	85	-	ns
	Read	tCYCR68	500	-	ns
Pulse rise / fall time		tR, tF	-	15	ns
Pulse width low	Write	tWLW68	27.5	-	ns
	Read	tWLR68	250	-	ns
Pulse width high	Write	tWHW68	27.5	-	ns
	Read	tWHR68	250	-	ns
RS,RW to CSB, E setup time		tAS68	10	-	ns
RS,RW to CSB, E hold time		tAH68	2	-	ns
CSB to E time		tCW68	15	-	ns
Write data setup time		tWDS68	40	-	ns
Write data hold time		tWDH68	15	-	ns
Read data delay time		tRDD68	-	200	ns
Read data hold time		tRDH68	5	-	ns

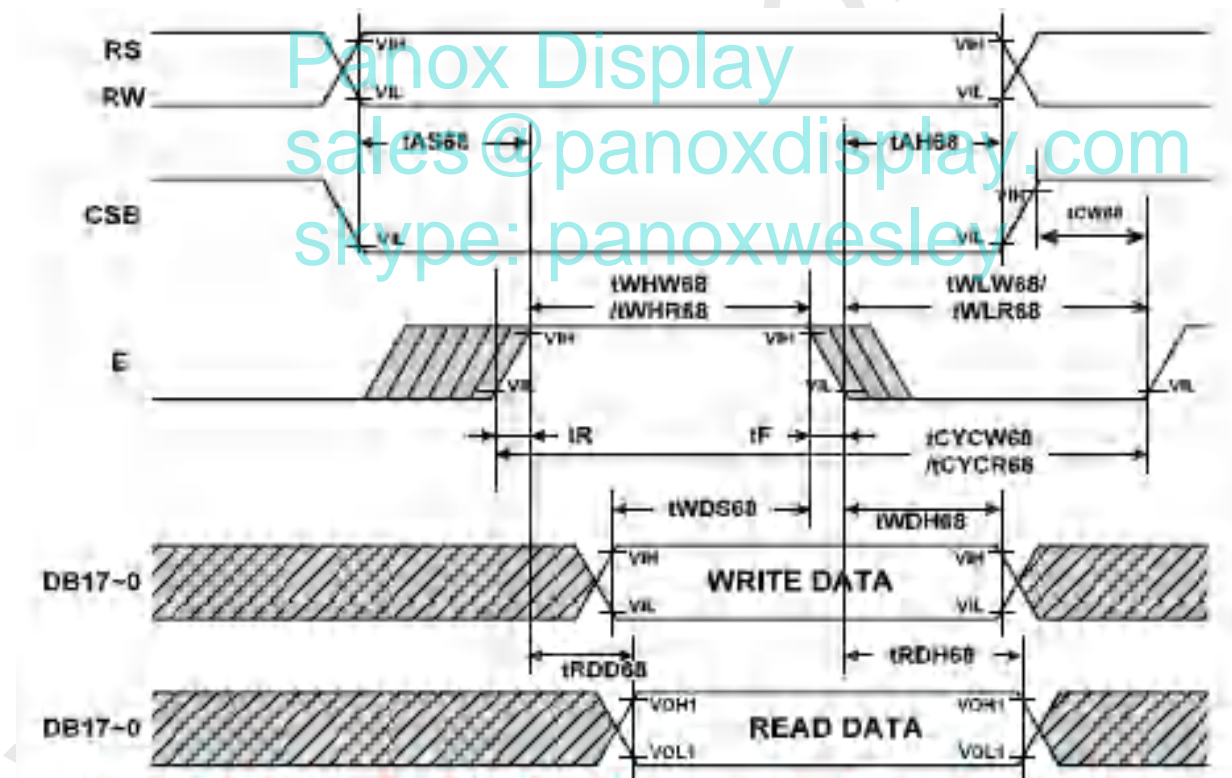

Note : tWHW68 and tWHR68 are determined by the overlap period of low CSB and high E

5.2.2 CPU interface M80

(VDD3 = 1.65 to 3.3V, TA = -40 to +85°C)

Characteristic		Symbol	Specification		Unit
			Min.	Max.	
Cycle time	Write	tCYCW80	85	-	ns
	Read	tCYCR80	500	-	ns
Pulse rise / fall time		tR, tF	-	15	ns
Pulse width low	Write	tWLW80	27.5	-	ns
	Read	tWLR80	250	-	ns
Pulse width high	Write	tWHW80	27.5	-	ns
	Read	tWHR80	250	-	ns
RS to CSB, WRB(RDB) setup time		tAS80	10	-	ns
RS to CSB, WRB(RDB) hold time		tAH80	2	-	ns
CSB to WRB(RDB) time		tCW80	15	-	ns
Write data setup time		tWDS80	40	-	ns
Write data hold time		tWDH80	15	-	ns
Read data delay time		tRDD80	-	200	ns
Read data hold time		tRDH80	5	-	ns

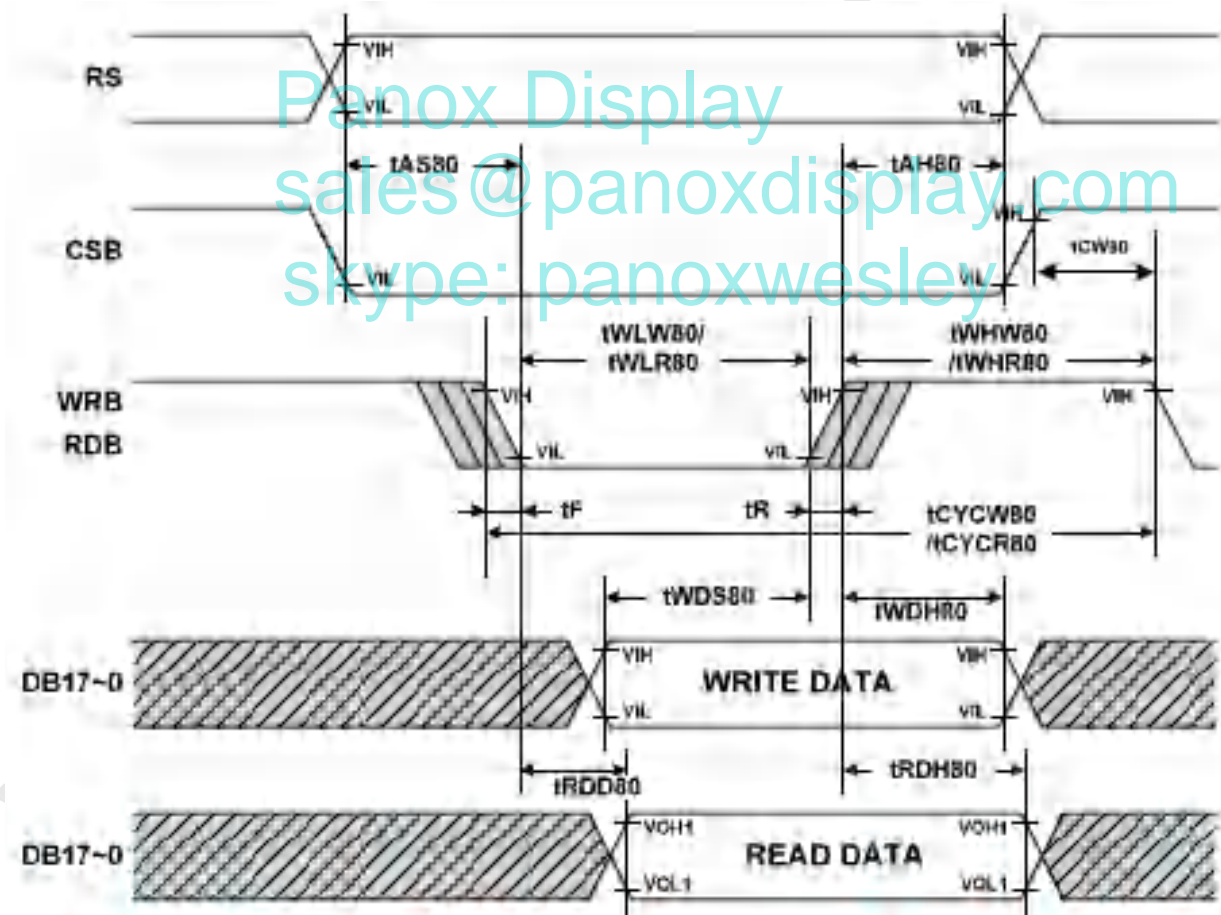

Note : tWLW80 and tWLR80 are determined by the overlap period of low CSB and low WRB or low CSB and low RDB

Image Data format for 18bit CPU interface (262k color)

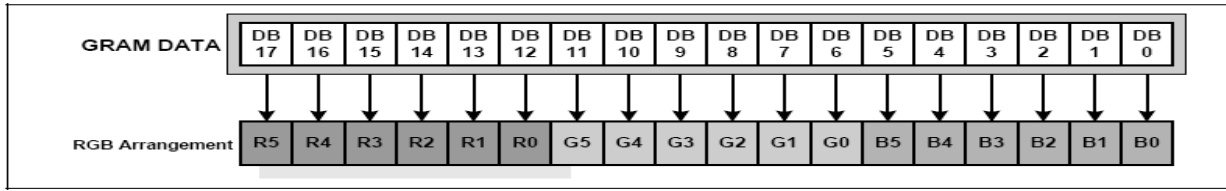

Image Data format for 16bit CPU interface (65k color)

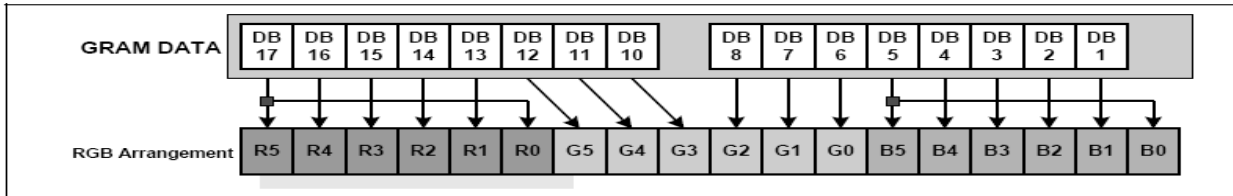

Image Data format for 9bit CPU interface (262k color)

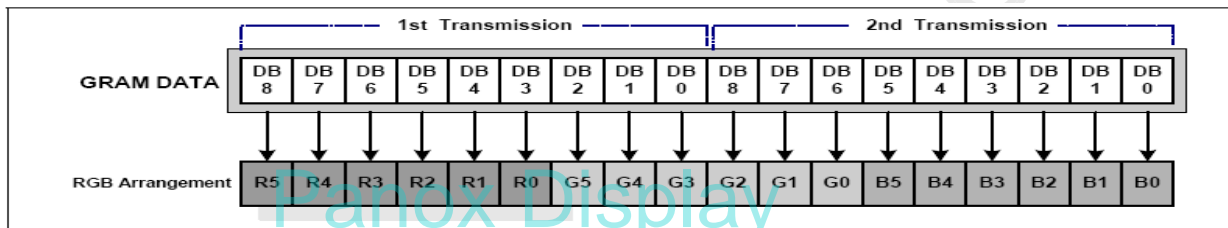
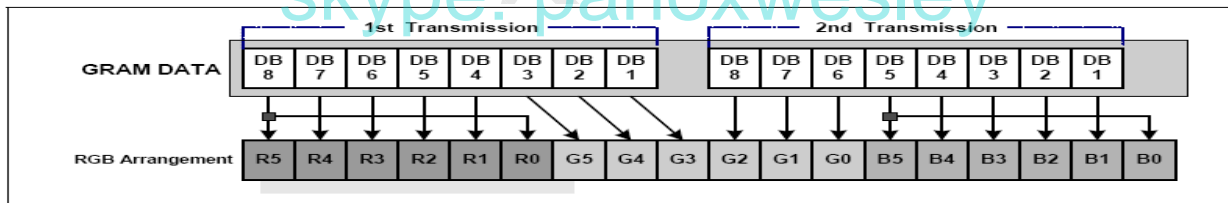

Image Data format for 8bit CPU interface (65K color)

Case 1:



Case 2:

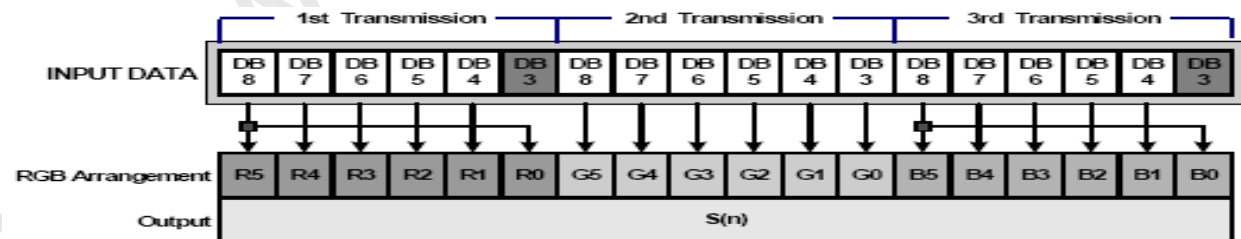
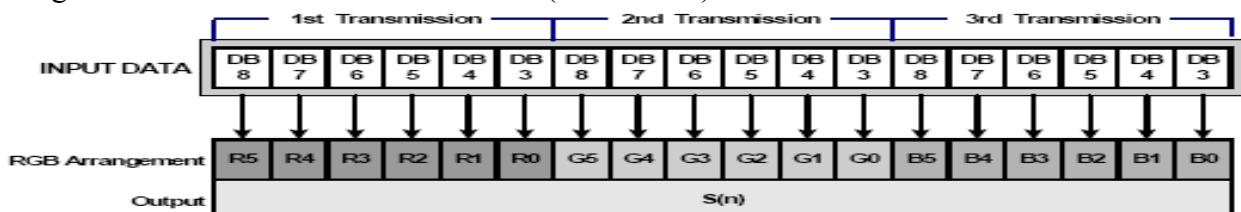

Image Data format for 8bit CPU interface (262K color)





5.2.3 SPI Interface

(VDD3 = 1.65 to 3.3V, TA = -40 to +85°C)

Characteristic	Symbol	Specification		Unit
		Min.	Max.	
Serial clock write cycle time	tSCYC	130	-	ns
Serial clock read cycle time	tSCYC	250	-	ns
Serial clock rise / fall time	tR, tF	-	15	ns
Pulse width high for write	tSCHW	50	-	ns
Pulse width high for read	tSCHR	110	-	ns
Pulse width low for write	tSCLW	50	-	ns
Pulse width low for read	tSCLR	110	-	ns
Chip select setup time	tCSS	20	-	ns
Chip select hold time	tCSH	60	-	ns
Serial input data setup time	tSIDS	30	-	ns
Serial input data hold time	tSIDH	30	-	ns
Serial output data delay time	tSODD	-	130	ns
Serial output data hold time	tSODH	5	-	ns

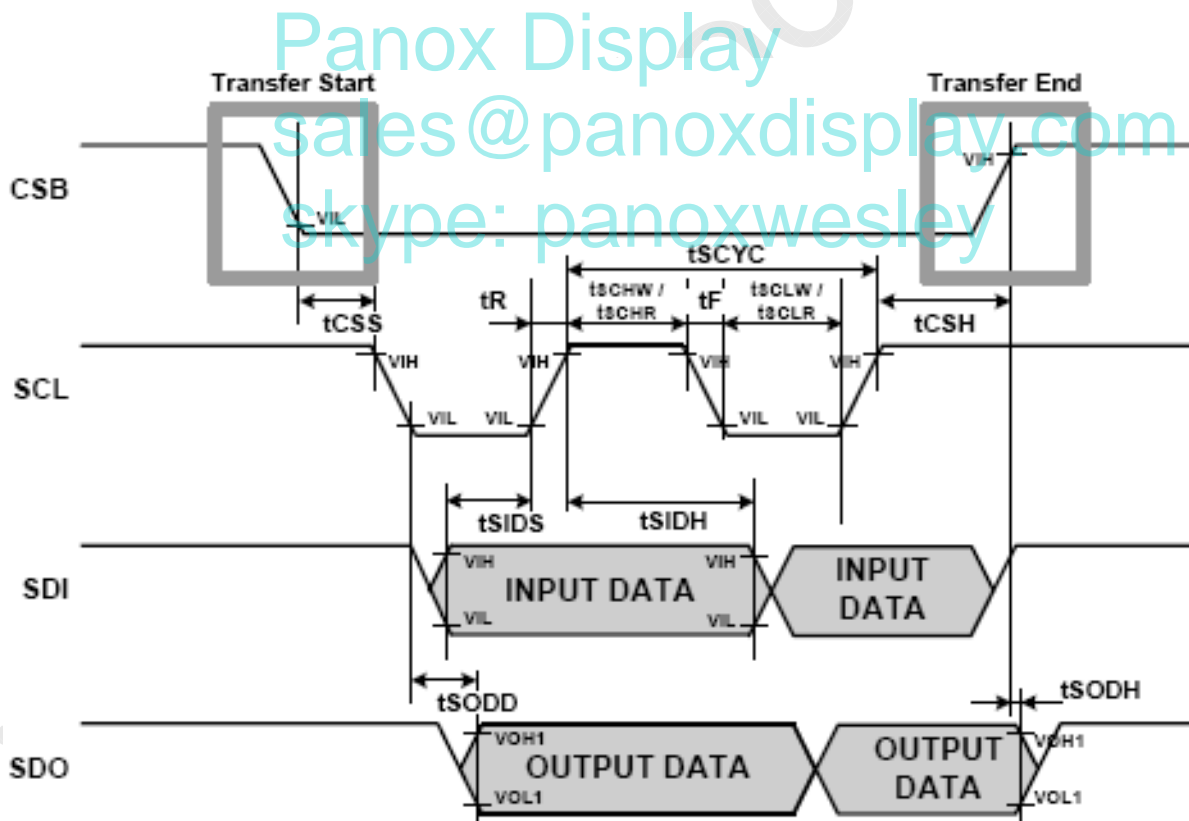

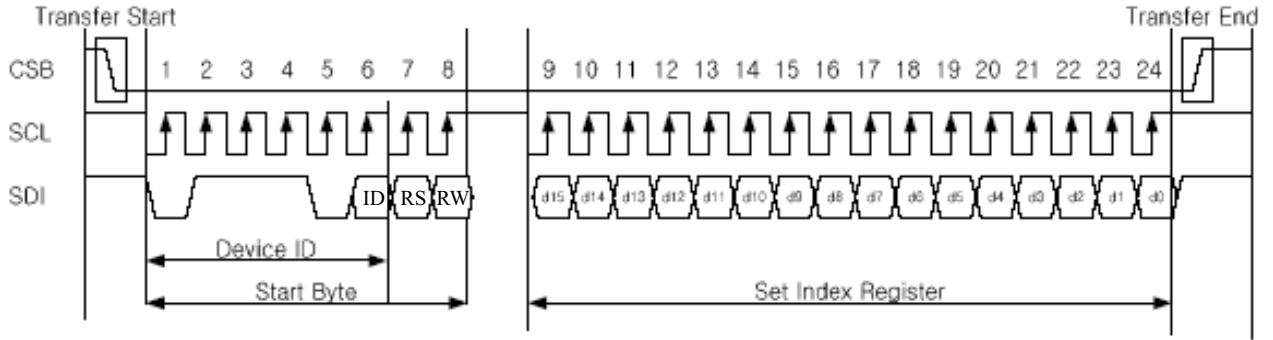

(Note) RS = 0 : Index data
 RS = 1 : Parameter data

Panox Display
sales@panoxdisplay.com
 skype: panoxwesley

5.2.4 RGB Interface

(VDD3 = 1.65 to 3.3V, TA = -40 to +85°C)

Characteristic	Symbol	Specification		Unit		Unit
		Min.	Max.	Min.	Max.	
DOTCLK cycle time	tDCYC	100	-	55	-	ns
DOTCLK rise / fall time	tR, tF	-	15	-	15	ns
DOTCLK pulse width high	tDCHW	40	-	25	-	ns
DOTCLK pulse width low	tDCLW	40	-	25	-	ns
Vertical sync setup time	tVSYH	30	-	30	-	ns
Vertical sync hold time	tVSYL	30	-	30	-	ns
Horizontal sync setup time	tHSYS	30	-	30	-	ns
Horizontal sync hold time	tHSYL	30	-	30	-	ns
ENABLE setup time	tENS	30	-	30	-	ns
ENABLE hold time	tENH	20	-	20	-	ns
PD data setup time	tPDS	30	-	30	-	ns
PD data hold time	tPDH	20	-	20	-	ns
HSYNC-ENABLE time	tHE	1	HBP	1	HBP	tDCYC
VSYSNC-HSYNC time	tHV	1	175	1	527	tDCYC

Note

1. HBP is horizontal back-porch.

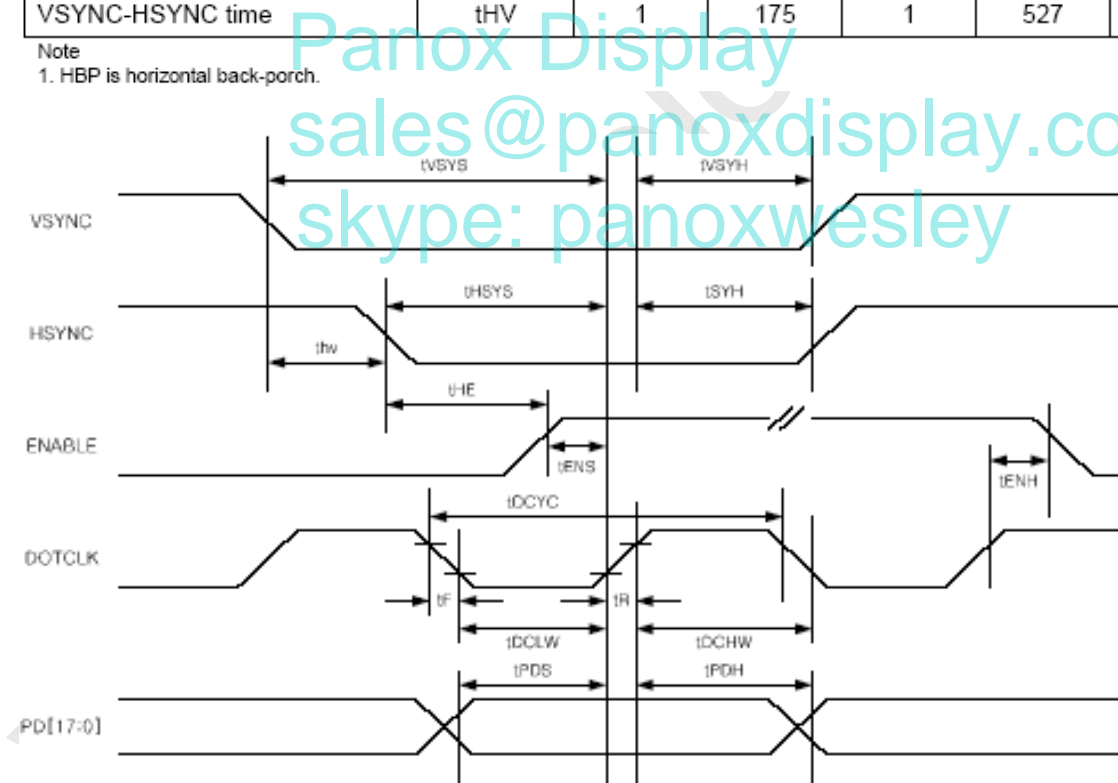

(When VSPL=0, HSPL=0, DPL=0, EPL=1)

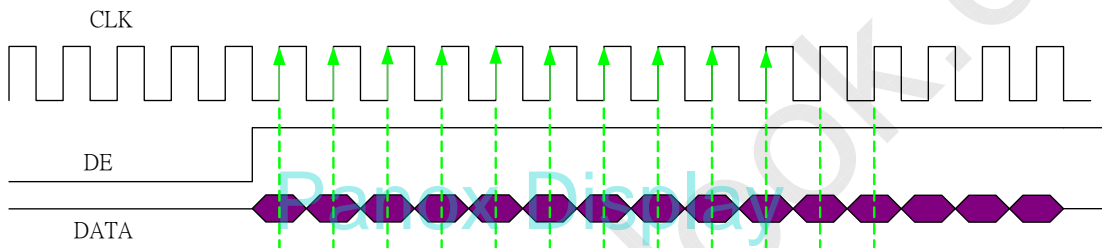
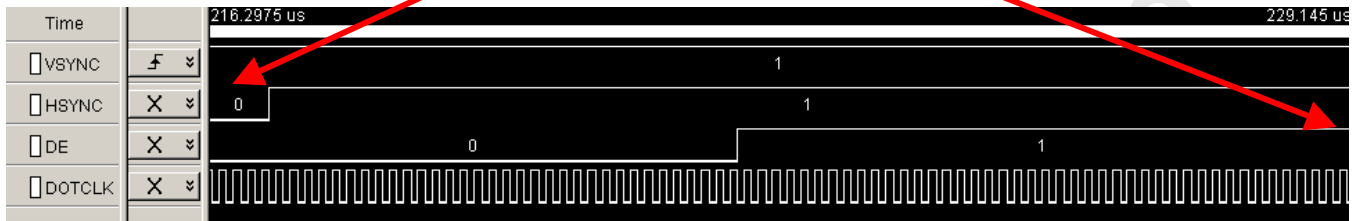
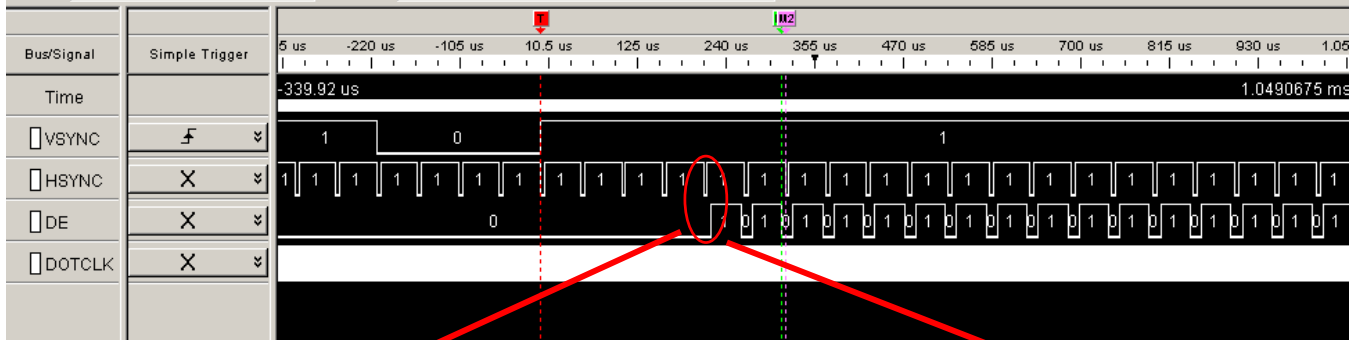

Image Data format for 18bit RGB interface (262k color)

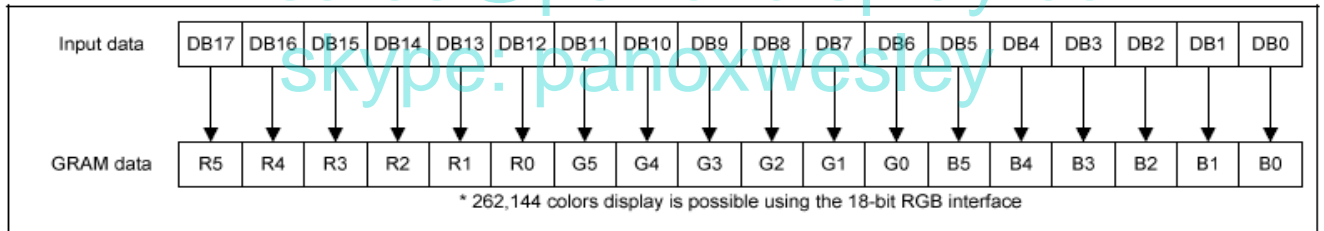

Image Data format for 16bit RGB interface (65k color)

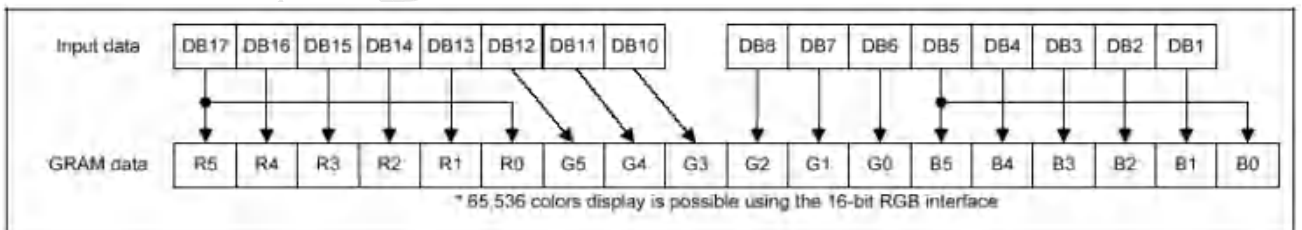
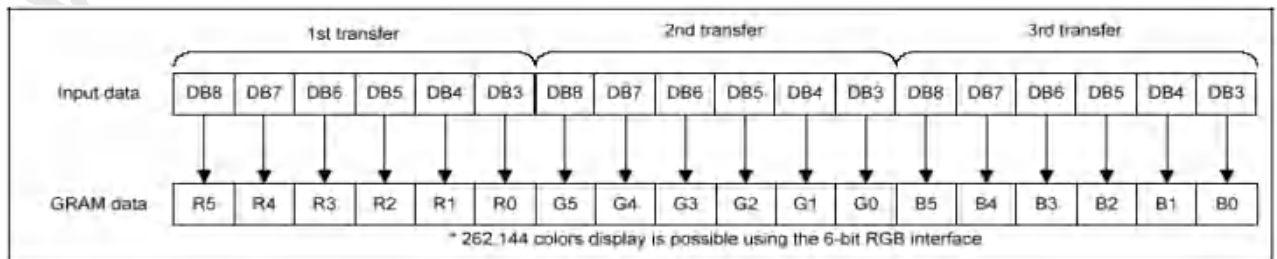

Image Data format for 6bit RGB interface (262k color)



6. Electro-Optical Characteristic:

Items	Symbol	Min	Typ.	Max	Unit	Remark
Operating Luminance	L	135	160	185	Cd/m ²	(1)(5)
Power Consumption	Pon	-	350	400	mW	30% pixels on (1)
Max. Current	Icc	-	-	162	mA	(1)
Response Time	Tres	-	-	50	us	(2)
CIE _x (White)	W _x	0.26	0.31	0.36	-	(5)
CIE _y (White)	W _y	0.28	0.33	0.38	-	(5)
CIE _x (Red)	R _x	0.62	0.66	0.70	-	(5)
CIE _y (Red)	R _y	0.30	0.34	0.38	-	(5)
CIE _x (Green)	G _x	0.25	0.29	0.33	-	(5)
CIE _y (Green)	G _y	0.62	0.66	0.70	-	(5)
CIE _x (Blue)	B _x	0.11	0.15	0.19	-	(5)
CIE _y (Blue)	B _y	0.12	0.16	0.20	-	(5)
Viewing Angle	VA	160	170	-	Degree	(3)
Contrast	CR	5000:1	10000:1	-		(4)
Operation Lifetime	LTop	30000	-		Hrs	(1)(6)

Note:

Measuring surrounding: Dark room

Surrounding temperature: 25°C

IOVCC = 1.65V ~ 3.3V

1. Test condition:

a. AR_VDD= 4.6V+/- 0.03V, AR_VSS= -4.4V+/- 0.03V

b. IC Initial Register Setting:

R03h: 0x0030 // 16bit mode
 R10h: 0x0000 // IC standby off
 R18h: 0x0028 // Frame Rate = 80 Hz
 RF8h: 0x000F // VGH=+5V
 RF9h: 0x000F // VGL=-5V
 R05h: 0x0001 // display on

Gamma Register Setting: (Gamma Setting Code : A)

R70h: 0x2580
 R71h: 0x2780
 R72h: 0x3380
 R73h: 0x1D18
 R74h: 0x1F11
 R75h: 0x2419
 R76h: 0x1A14
 R77h: 0x211A
 R78h: 0x2013

2. Response Time test condition

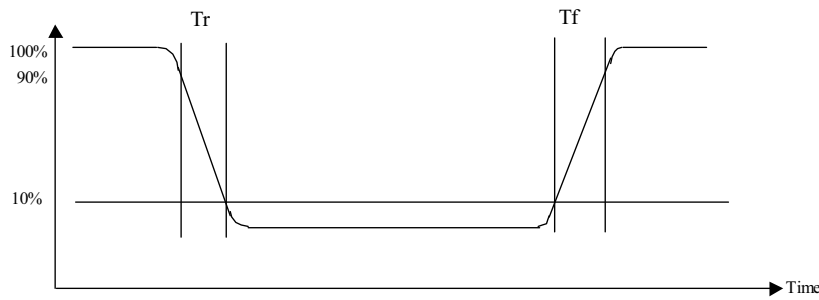

3. Viewing angle test condition:

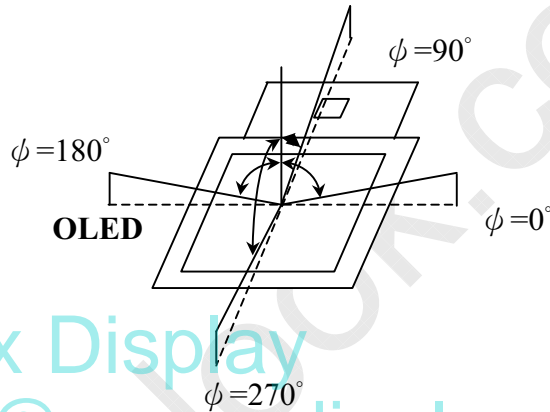

Viewing Angle = $CR > 10$

4. Contrast

$$CR = \frac{\text{Luminance with all pixels white}}{\text{Luminance with all pixels black}}$$

5. Optical tester: CA210

6. Brightness of 30% power consumption. Operating Life Time is defined when the luminance has decayed to less than 50% of the initial measured luminance before life test.

7. System Diagram:

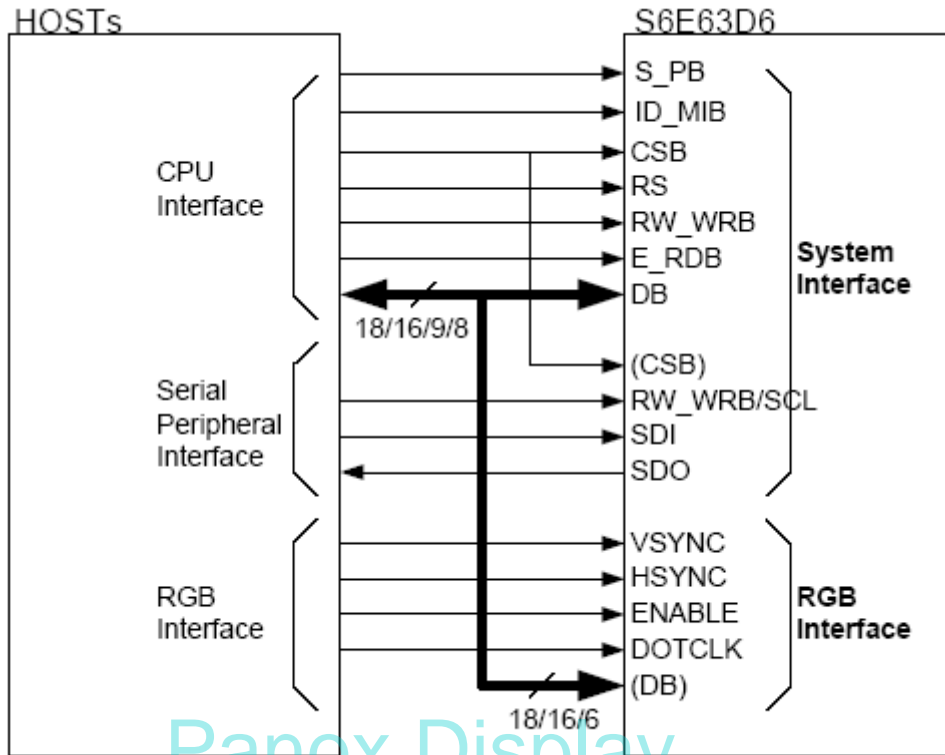

Panox Display
sales@panoxdisplay.com
 skype: panoxwesley



8. Pin Assignment:

PIN	Symbol	I/O	Description	Remarks
1	AR_VDD	I	Positive voltage for OLED(+4.6V)	
2	AR_VSS	I	Negative voltage for OLED(-4.4V)	
3	VCI	I	Power supply for analog circuit(2.5v~3.3v)	
4	VCI1	O	A reference voltage for 1 st booster(connect a 1u/10v capacitance to gnd)	
5	GND	I	Ground	
6	C12M	I	External capacitance connect pin between C12M and C12P (1u/10V)	
7	C12P	I		
8	C11M	I	External capacitance connect pin between C11M and C11P	
9	C11P	I		
10	VLOUT1	O	1 st booster output pin. (1u/10V)	
11	C31P	I	External capacitance connect pin between C31M and C31P (1u/10V)	
12	C31M	I		
13	C32P	I	External capacitance connect pin between C32M and C32P (1u/10V)	
14	C32M	I		
15	VLOUT3	O	3 rd booster output pin. (1u/16V)	
16	VLOUT2	O	2 nd booster output pin. (1u/16V)	
17	C21P	I	External capacitance connect pin between C21M and C21P. (1u/10V)	
18	C21M	I		
19	VGS	I	A reference level for the grayscale voltage generation circuit. (connect to gnd)	
20	IOVCC	I	I/O power supply	
21	SPB	I	Select the CPU interface mode. (0=parallel interface 1=serial interface)	
22	ID_MIB	I	Select the CPU type (0=intel 80x-system 1=motorola 68x-system)	
23	DB17	I/O	BI-directional data bus. When CPU I/F, 18-bit interface : DB 17-0 16-bit interface : DB 17-10 , DB 8-1 9-bit interface : DB 8-0 8-bit interface : DB 8-1 When RGB I/F 18-bit interface : DB 17-0 16-bit interface : DB 17-10, DB 8-1 6-bit interface : DB 8-3 Fix unused pin to the VSS level	
24	DB16	I/O		
25	DB15	I/O		
26	DB14	I/O		
27	DB13	I/O		
28	DB12	I/O		
29	DB11	I/O		
30	DB10	I/O		
31	DB9	I/O		
32	DB8	I/O		
33	DB7	I/O		

34	DB6	I/O				
35	DB5	I/O				
36	DB4	I/O				
37	DB3	I/O				
38	DB2	I/O				
39	DB1	I/O				
40	DB0	I/O				
41	VSYNC	I	Frame-synchronizing signal. (VSPL=0 Low active, VSPL=1 High active) FIX this pin at VSS level if the pin is not used			
42	HSYNC	I	Line-synchronizing signal. (HSPL=0 Low active, HSPL=1 High active) FIX this pin at VSS level if the pin is not used			
43	DOTCLK	I	Input pin for clock signal of external interface : dot clock. DPL=0 Display data is fetched at DOTCLK's rising edge DPL=1 Display data is fetched at DOTCLK's falling edge Fix this pin at VSS level if the pin is not used.			
44	ENABLE	I	Data enablesignal pin for RGB interface.			
			EPL	ENABLE	GRAM write	GRAM address
			0	0	Valid	Updated
			0	1	Invalid	Held
			1	0	Invalid	Held
1	1	Valid	Updated			
45	SDI (SDIN)	I	For a serial peripheral interface (SPI), input data is fetched at the rising edge of the SCL signal. Fix SDI pin at VSS level if the pin is not used.			
46	SDO (SDOUT)	O	For a serial peripheral interface (SPI), serves as the serial data output pin (SDO), Successive bits are output at the falling edge of the SCL signal.			
47	CSB (CS/NCS)	I	Chip select signal input pin. 0= driver IC is selected and can be accessed. 1= driver IC is not selected and cannot be accessed.			
48	RW_WRB (SCL)	I	Pin function	CPU type	Pin description	
			RW	68-system	Read/Write operation selection pin 0=write 1=read	
			WRB	80_system	Write strobe signal.(Input pin) Data is fetched at the rising edge.	
			SCL	SPI	The synchronous clock signal	
49	RS	I	Register select pin. 0=Index/status, 1=instruction parameter, GRAM data Must be fixed at VDD3 level when not used.			
50	E_RDB	I	Pin Function	CPU type	Pin description	
			E	68-system	Read/Write operation enable pin	
			RDB	80_system	Read strobe signal. Read out data at the low level	
When SPI mode is selected, fix this pin at VDD3 level						
51	RESETB	I	Reset pin initializes the IC when low. Should be reset after power-on.			
52	MVDD	O	Internal power for RAM. Connect a capacitance (1u/10v) to gnd.			
53	VREG1OUT	O	A reference level for the grayscale voltage. Connect a capacitance (1u/10v) to gnd.			
54	VCI	I	Power supply for analog circuit (2.5v~3.3v)			



55	VGH	O	The positive voltage used in the gate driver. Connect a capacitance (1u/10v) to gnd.	
56	VGL	O	The negative voltage used in the gate driver. Connect a capacitance (1u/10v) to gnd.	
57	GND		Ground	
58	X-		For touch screen	
59	Y-		For touch screen	
60	X+		For touch screen	
61	Y+		For touch screen	

Panox Display
sales@panoxdisplay.com
skype: panoxwesley

9. Reliability Test:

No.	Items	Specification
1	High Temp. Storage	85°C, 240hrs
2	Low Temp. Storage	-40°C, 240hrs
3	High Temp. Operation	60°C, 240hrs
4	Low Temp. Operation	-40°C, 240hrs
5	High Temp / Humidity Storage	85°C, 85%RH, 240hrs
6	High Temp / Humidity Operation	60°C, 90%RH, 240hrs
7	Thermal shock	-40°C ~85°C (-40°C /30min; transit/3min; 85°C /30min; transit /3min) 1cycle: 66min, 100 cycles
8	Vibration	Frequency: 5~50HZ, 0.5G Scan rate : 1 oct/min Time : 2 hrs/axis Test axis : X, Y, Z
9	Drop	Height: 76cm Sequence : 1 angle 、 3 edges and 6 faces Cycles: 1
10	ESD	Air discharge model, ±8kV, 10 times

Test and measurement conditions

- All measurements shall not be started until the specimens attain to temperature stability.
- The degradation of Polarizer is ignored for item 1, 5 & 6.
- The test pattern at operating condition is 30%P.C. alternating pictures.

Evaluation Criteria

- No damage to glass or encapsulation
- No drastic change to display
- Defects / Mura follow product specification
- Luminance: Within +/-50% of initial value
- Current consumption: within +/-50% of initial value



10. Handling:

- 10.1 Do not scratch the surface of the polarizer film as it is easily damaged.
- 10.2 When cleaning the display surface, use soft cloth with solvent (as recommended below) and wipe lightly
 - Ethyl alcohol
 - Isopropyl alcohol
- 10.3 Do not wipe the display surface with dry or hard materials that damage the polarizer surface.
- 10.4 Since this OLED panel is made of glass, dropping the module or banging it against hard objects may cause cracks or fragmentation.
- 10.5 Do not disassemble the OLED module as it may cause permanent damage.
- 10.6 Hold OLED very carefully when placing OLED module into the system housing. Do not excessive stress or pressure to OLED module.

11. Storage

- 11.1 Storing in a polyethylene bag with the opening sealed.
- 11.2 Placing in a dark place where neither exposure to direct sunlight nor any fluorescent light is permitted and keep at room temperature & room humidity.
- 11.3 Storing with no contact with polarizer surface.

(It is recommended to store them in the inner container which we delivered.)

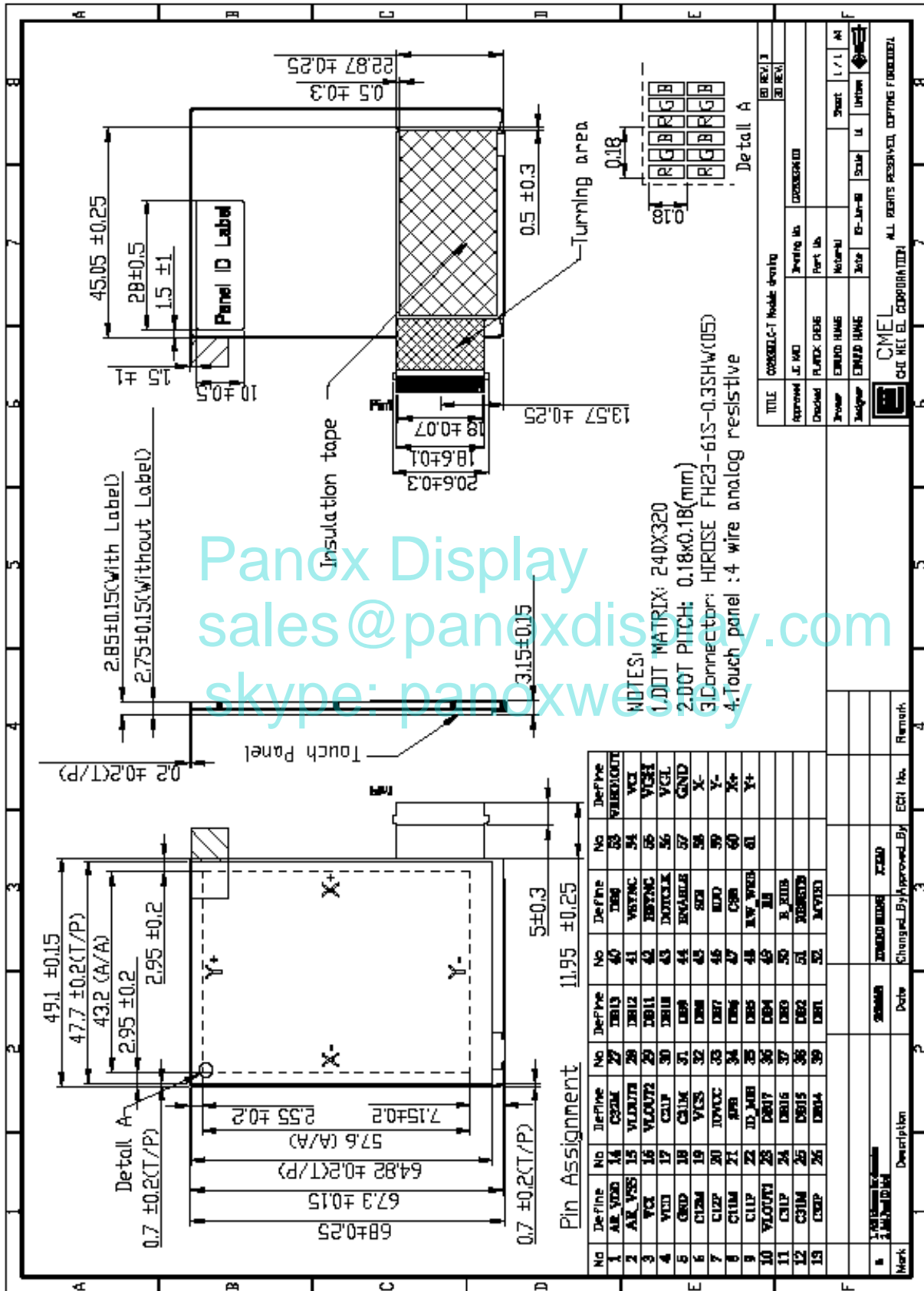
12. External Dimension:



12.1 Cautions for installing and assembling:

Bezel edge must be positioned in the area between the Active area and View area. The bezel may press the touch screen and cause activation if the edge touches the active area. A gap of approximately 0.5mm is needed between the bezel and the top electrode. It may cause unexpected activation if the gap is too narrow. There is a tolerance of 0.2 to 0.3mm for the outside dimensions of the touch panel and tail. A gap must be made to absorb the tolerance in the case and connector.

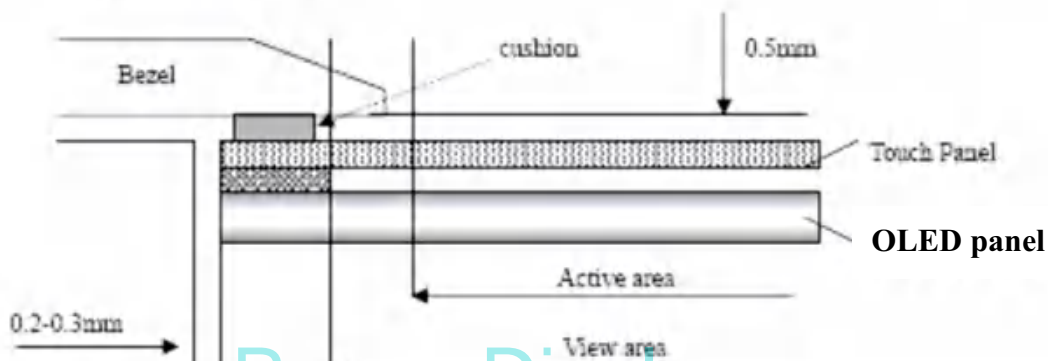

Panox Display
sales@panoxdisplay.com
skype: panoxwesley

13. Package:

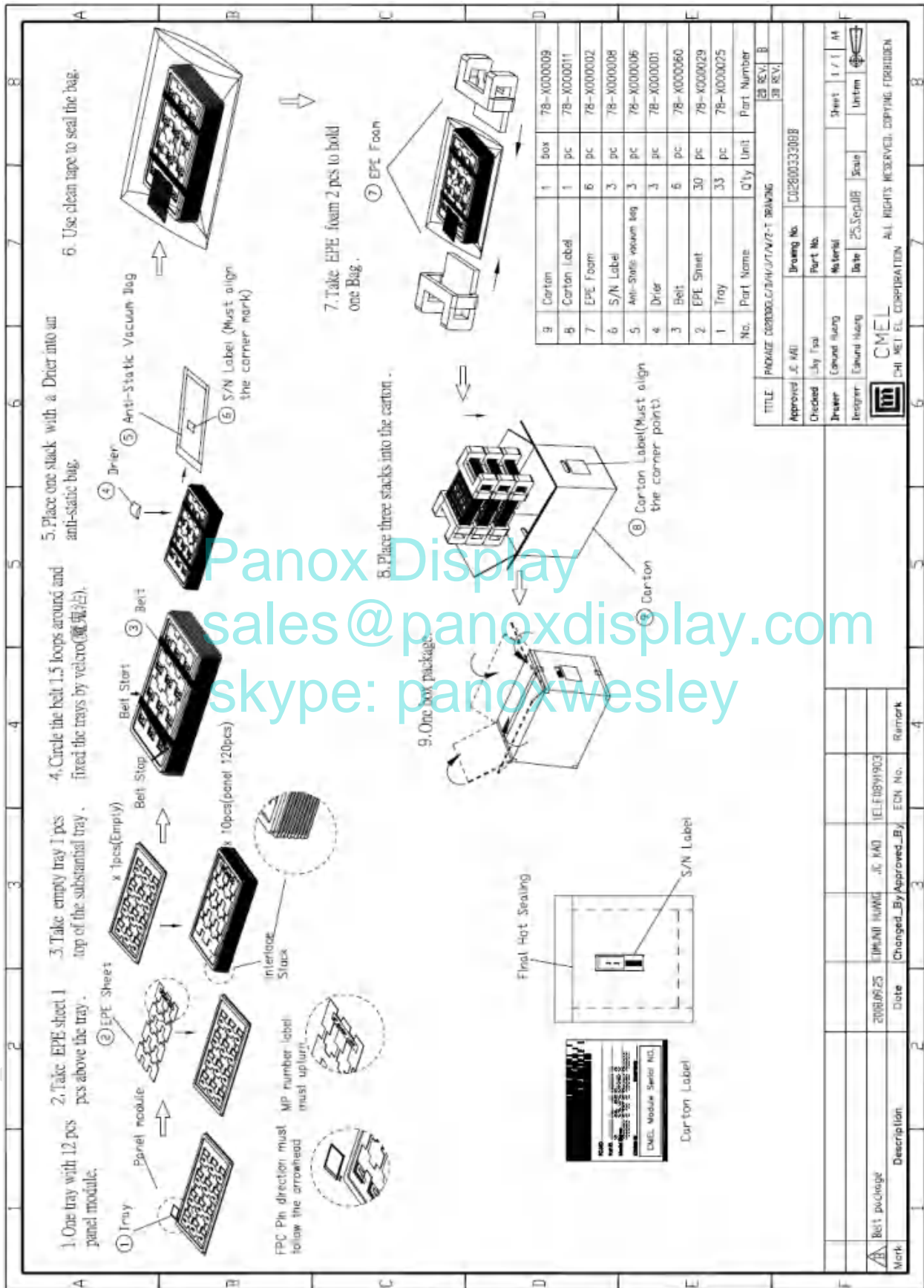

1. One tray with 12 pcs panel module.

2. Take EPE sheet 1 pcs above the tray.

3. Take empty tray 1 pcs top of the substantial tray.

4. Circle the belt 1.5 loops around and fixed the trays by velcro (魔術貼).

5. Place one stack with a Drier into an anti-static bag.

6. Use clean tape to seal the bag.

7. Take EPE foam 2 pcs to hold one Bag.

8. Place three stacks into the carton.

9. One box package.

① Tray
② EPE Sheet
③ Belt
④ Drier
⑤ Anti-Static Vacuum Bag
⑥ S/N Label (Must align the corner mark)
⑦ EPE Foam
⑧ Carton Label (Must align the corner point)
⑨ Carton

FPC Pin direction must follow the arrowhead.

MP number label must upright.

Interface Stack x 10pcs (panel 120pcs)

Panel module
Belt Stop
Belt Start

Final Hot Sealing

Carton Label
S/N Label

No.	Part Name	Q'ty	Unit	Part Number
9	Carton	1	box	78-X000009
8	Carton label	1	pc	78-X000011
7	EPE Foam	6	pc	78-X000002
6	S/N Label	3	pc	78-X000008
5	Anti-Static vacuum bag	3	pc	78-X000006
4	Drier	3	pc	78-X000001
3	Belt	6	pc	78-X000060
2	EPE Sheet	30	pc	78-X000029
1	Tray	33	pc	78-X000025

TITLE	PACKAGE 0028000.C/28000/28000/28000
Approved By	J. M. Li
Decided By	F. Y. Fan
Drawn	General Huang
Inspector	Edward Huang
Issue No.	002800033208B
Part No.	
Material	
Date	25/09/2008
Scale	1/1 A4
Sheet	1 / 1
Unit	

CMEL
CHI MEI EL CORPORATION
ALL RIGHTS RESERVED. COPYING FORBIDDEN

Mark					
Description					
Date	2008/09/25	Changed By	J. M. Li	ECN No.	
Remark					